

WORKIO™

DIGITAL IMAGING SYSTEMS

Panasonic
DP-6010

- 60 ppm Digital Input and Output System
- Standard Copying/Network Printing/Document Management
- Powerful Upgrades for Incredible Multifunctionality
- Advanced Network and Job Management Capability

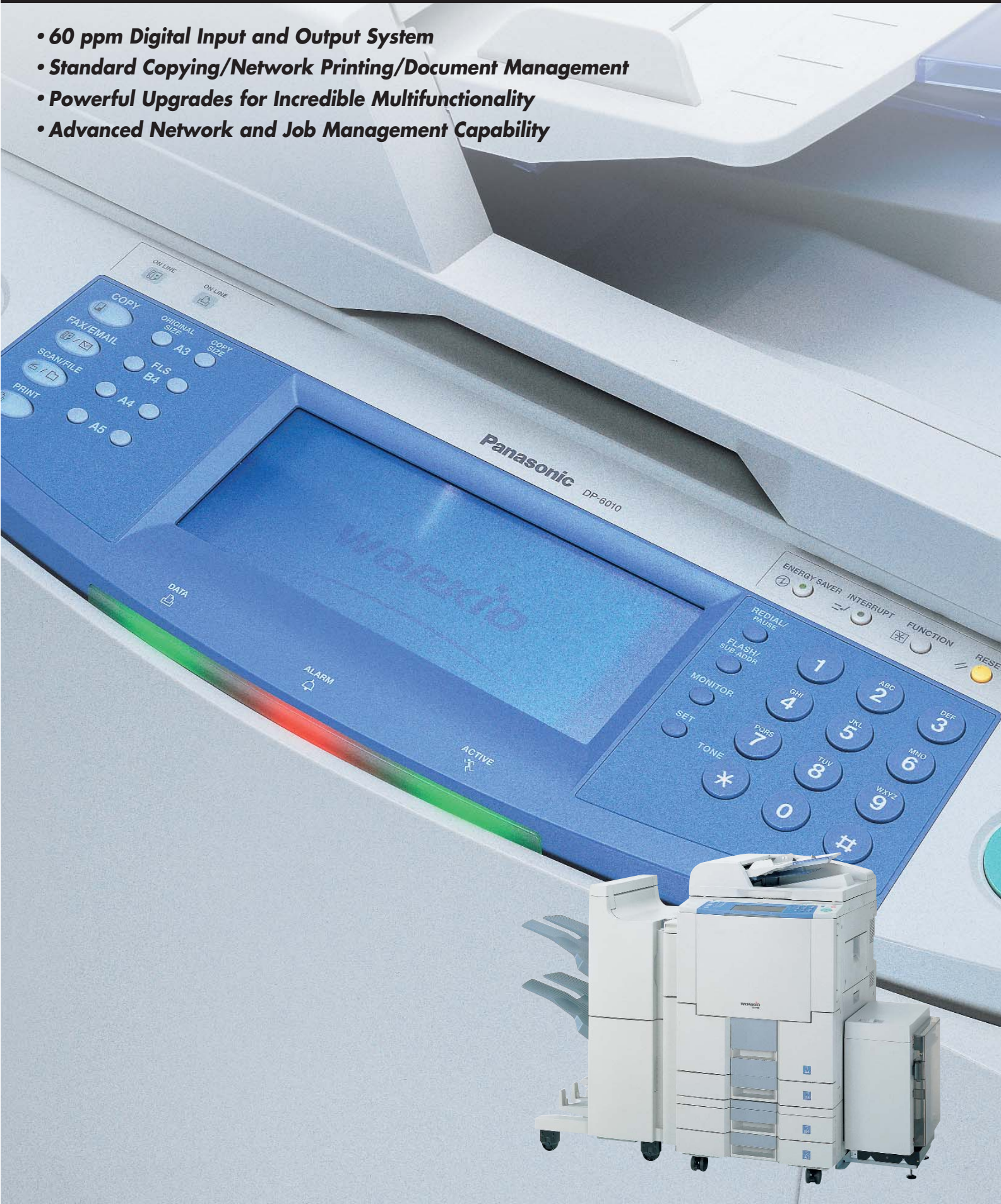



Panasonic's WORKiO Digital Imaging Systems have set the standards for office document systems with integrated input/output, reliable performance, and ease of use. From paper to digital, from input to output...WORKiO is a powerful tool for today's office.

WORKiO: The Simple Solution For High-Performance, High-Volume Office Document Processing



Holding a leading place in the MFP marketplace has never been a challenge for the Panasonic WORKiO lineup. The new WORKiO DP-6010 combines multiple functionality in a single console, offering numerous features that surpass the demanding needs required in today's busy work environment. From copying, printing and scanning, to faxing and e-mail, this network-ready digital imaging system does it all. Every document processing function contributes to greater office efficiency and productivity as well as help reduce costs.



Simple Operability, Smart Processing, Smooth Networking

Nothing is more frustrating than having a machine that is so complex, no one can figure out how to use it. That's why Panasonic put extra effort into designing a machine that's complex on the inside, yet simple and easy-to-use on the outside.

Instead of a tiny LCD screen that shows brief, cryptic messages, the WORKiO DP-6010 comes with an oversized LCD

touch panel that lets you choose what you want to do and immediately shows you what you're going to get. No more guesswork, or hunting for the manual. With the intuitive graphical interface, you'll always know exactly what you're doing and what the results will be. So you won't waste time and paper by using the wrong settings or the wrong document.

And, of course, the WORKiO DP-6010 is built tough with a rugged chassis designed to handle the wear and tear of years of service. Key components and consumables have also been designed to provide as long a service life as possible, while power consumption and noise/ozon emission have been minimized to assure a safe, comfortable and economical operating environment.

Streamlined Document Workflow

Best of all, WORKiO works. With built-in network connectivity, the WORKiO DP-6010 can plug into any network — from small, local networks to corporate backbone systems. Functioning as an on-ramp to the Internet, the WORKiO DP-6010 provides Internet capabilities that make it easy for you to stay connected in today's world. The "Send to PC"*1 and "Send to E-mail"*2 features send scanned documents directly to any PC on your LAN or to an e-mail application at the touch of a button.

With network connectivity, laser-quality, user-friendly design, and multitasking capabilities, the WORKiO DP-6010 is a today's most practical solution for maximizing office productivity and reducing TCO.

The new-generation WORKiO from Panasonic. Building the office of the future.

*1 Optional Network Scanner Module required.
*2 Optional Internet Fax/E-mail Module required.

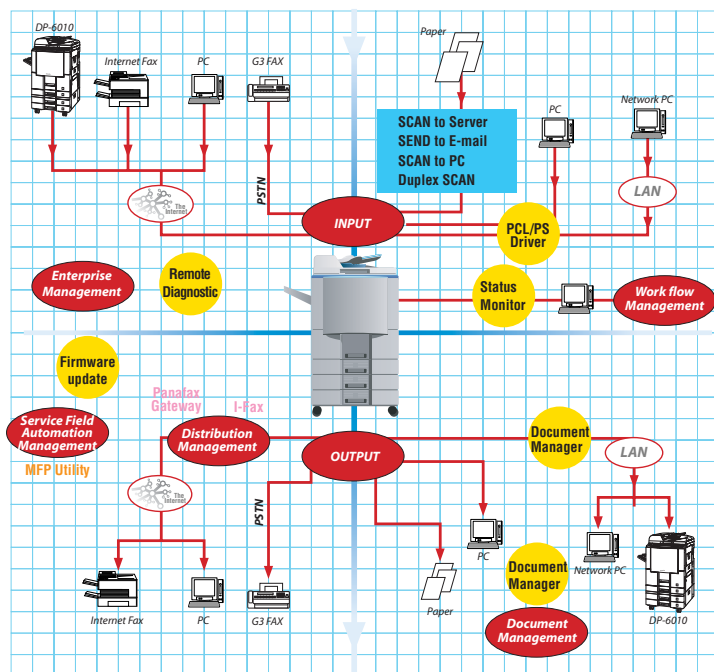

WORKiO Solutions for

Productive Copying & Intuitive Operation

High-speed Digital Copying

With the ability to pump **60 A4-size copies per minute**, the WORKiO DP-6010 brings real document processing power to your office. Thanks to its **high-performance** microprocessor, the WORKiO DP-6010 features a fast **first copy time** and lightning-quick output – it never keeps you waiting. The WORKiO DP-6010 also comes with a built-in **“stackless” duplex unit** for hassle-free, high-speed duplex copying.

Enhanced Graphical User Interface

The WORKiO DP-6010's user-friendly design makes even complicated jobs a snap. The comprehensive control panel with a large touch-sensitive LCD display gives you quick access to any function and simplifies even complicated operations. When you press the COPY button, the **half-VGA (640 x 240 pixels) LCD** display shows you both the original image and the final output. If you're operating the WORKiO DP-6010 remotely, a **completion notice** will be sent to your PC when the copy job is finished. With this **original/finished image display**, WORKiO makes simple, trouble-free operation a reality and effectively puts an end to mis-copying.

- High-speed, high-volume copying with fast first copy.
- Large LCD panel with graphical display eliminates mis-copying.
- Finishing versatility & network-intensive copying solution.
- High-quality image reproduction capability.

WORKiO Advantages

Got a problem?
WORKiO has a solution.

“Copy complications”

- Large copy jobs create a bottleneck, slowing down work productivity.
- A misplaced page or a text error results in starting a time-consuming high-volume job all over again.
- High-volume copying and binding jobs are tricky and complicated.



[COPY]

eliminates mis-copying

High Image Quality

In spite of its incredibly fast copying speed the WORKiO DP-6010 offers professional-quality **600 x 600 dpi resolution** with **256-level gray scale**. Newly-developed **image processing LSIs***1 greatly improve image processing speed and quality, while **ultra-fine toner/carrier particles** provide accurate image reproduction. The copies feature crisp, legible text with clear visibility of small characters and clear, sharp photos. Powerful **image stabilising technology** maintains the same superior quality across multiple generations regardless of environmental factors.

*1. Large Scale Integration

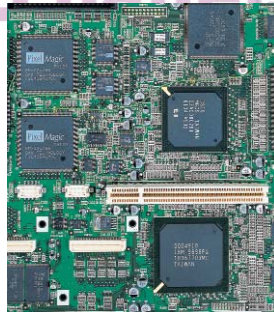

High-Volume Copying Capability

The standard extra-large capacity **1550-sheet A4-size paper cassette** can handle the most common high-volume copying requirements. Together with the 550-sheet standard paper tray, as well as the 50-sheet bypass tray, the WORKiO DP-6010 can hold **up to 2,150 sheets**. Need more? You can increase the paper capacity to a maximum of **6,250 sheets** of various sizes by adding two 550-sheet trays and a 3000-sheet cassette!



Digital Copy Conveniences

Digital image processing capability helps accelerate document production with features like **N-in-1 Copy** for copying multiple originals on a single sheet, **Zoom Copy** for specification of enlargement/reduction ratios, and **Image Rotation** for accurate copies regardless of paper orientation. The Automatic Document Feeder (ADF) unit, enables productivity-enhancing, high-speed **Duplex Copying**. **Sort Copy** electronically collates copies as shifted or rotated sets. The addition of the **expandable sorting memory** further enhances sorting capability, for even smoother, more efficient sorting.

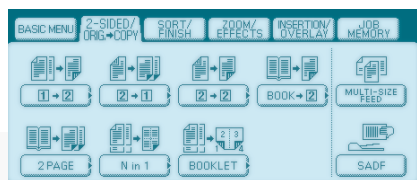
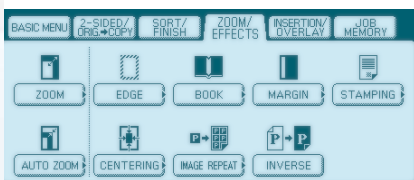

Network-intensive Copying Capability

The WORKiO DP-6010's inherent network connectivity further enhances copying convenience. **Concurrent Copy** allows the WORKiO DP-6010 to handle up to 12 different copy jobs at one time. For extra-large volume copying, the **Tandem Copy** function enables two WORKiO machines to function jointly on a single copy job, and with **Remote Copy**, you can send a copy job to another WORKiO located on another floor or in a different room. **Proof Copy** produces a first set of copies so you can double-check the results before starting a large volume copy job.

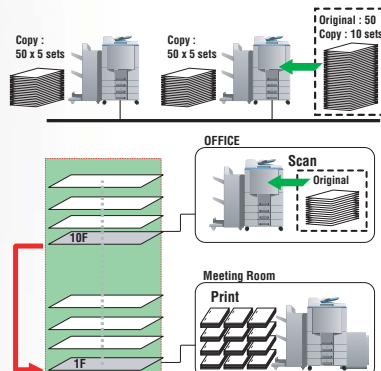

Complete Finishing Capability

The WORKiO DP-6010 is not just a high-volume copying machine, but a complete document finishing machine with **stapling, punching** and even **saddle stitching** capabilities. A **variety of finisher options** are available, allowing you to expand the WORKiO DP-6010's functionality as your business needs grow. As with normal copies, finished results such as stapled or punched images can be checked beforehand on the LCD screen.

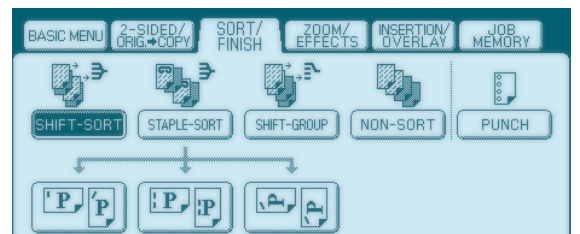

WORKiO Solutions for

Network Printer & Job Control Management

High-Speed Network Printer

The WORKiO DP-6010 comes standard with both a **10Base-T/100Base-TX Ethernet** interface and a parallel interface, so you can connect it directly to either a PC or your local area network (LAN). Super-fast **60 ppm (A4)** printing capability makes the WORKiO DP-6010 a superb network printer and its **A3 size** paper capability offers an added bonus rarely available with standard PC printers.

High-Quality Printing Images

In addition to true **600 x 600 dpi** printing resolution, Panasonic's exclusive Image Enhancement Technology further improves printout quality equivalent to **1200 dpi***1. The result is superb photo and graphics reproduction with clear, crisp details and smooth gradations. Small characters are completely legible even when superimposed on a coloured background. In addition to standard Windows® GDI printing, the WORKiO DP-6010 can handle **PCL or Adobe PostScript™** data when the optional printer driver is added. And, the built-in **automatic duplex unit** enhances printing flexibility even more.



Adobe PostScript 3

*1 Optional PCL Printer Controller Module required.

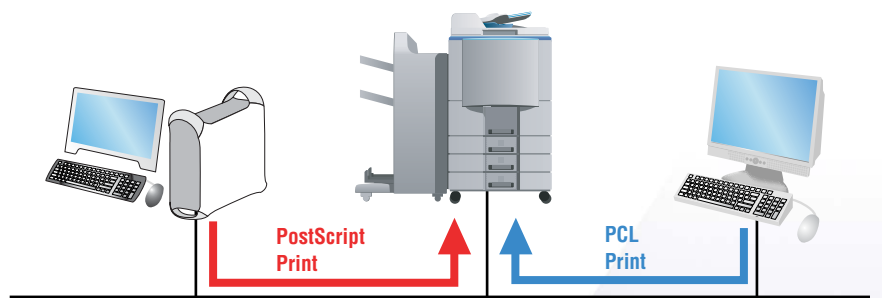

- High-speed, high-quality network printer performance.
- Comprehensive Printer Driver and Status Monitor.
- Intelligent job control systems

WORKiO Advantages

Got a problem? WORKiO has a solution.

“Printer traffic jams...”

- When the convenience of printing becomes an inconvenience
- When crucial documents get stuck in extended printer queues
- When you lose time sorting and finishing documents
- When there's not enough room for another machine

[PRINT]

intelligent job control

High-speed, high-quality

Intuitive Print Driver Control

The graphical **printer driver** screen makes it easy to control a WORKiO DP-6010 located in a remote area – directly from your desktop. While checking the virtual printed results on the left side of the printer you can specify printing commands via the easy-to-use **graphical user interface**. Finished results like sorted, stapled or hole punched can be confirmed on-screen, eliminating errors. The new visual **Status Monitor** enables you to check the current status of a WORKiO DP-6010 located in a remote area allowing you to quickly respond to problems such as low toner or paper supply.

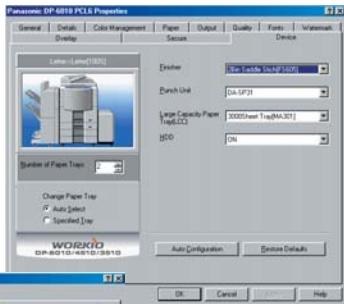

Select print or delete

OWNER	TITLE	TIME	NUM. OF SETS	PAGES	JOB TIME	
1234567890	12345678901234	12:34	999	999	9999min	SELECT ALL
MRCS	sfd_spec.doc	12:30	050	050	0500min	PRINT
1234	Rapid.doc	12:00	100	100	1000min	DELETE
500	Holiday.doc	11:45	000	000	0000min	CLOSE

01/03

Console Management System

(with MetaConsole™ technology licensed by Netaphor™ Software)

With this console management system, you can link WORKiO to a popular **Enterprise Console System** (such as HP OpenView, Tivoli Enterprise, Microsoft Management Console (MMC)) and set it up as device that can be managed by the console.

* MetaConsole™ is a registered trademark of Netaphor™ Software Inc.

Print Data Storage Box

Inside the WORKiO DP-6010 you can store printing data in your **Mail Box***2 or **Security Box***2. This special hard disk area can be used as a personalised disk space for up to 100 different users. With your User ID specified, you can store printing data for output later, so you don't have to keep your PC and application on after sending it to your Mail/Security Box. **High security levels** are available with 8-digit User ID's and 4-digit Passwords to protect the stored printed data.

*2 Optional Hard Disk Drive Unit required.



Intelligent Job Control Management

The enhanced graphical LCD display, enables you to view and even delete the **Print Queue** for each copy or print job, while approximate **Job Time** display is convenient for reduction of TCO (total cost of ownership). If the WORKiO DP-6010 is on a network, the network administrator not only monitors **device status** with the job queue and other WORKiO controls, but can also **set up or configure** the WORKiO DP-6010. This is

especially convenient when changing the machine configuration or updating the firmware.

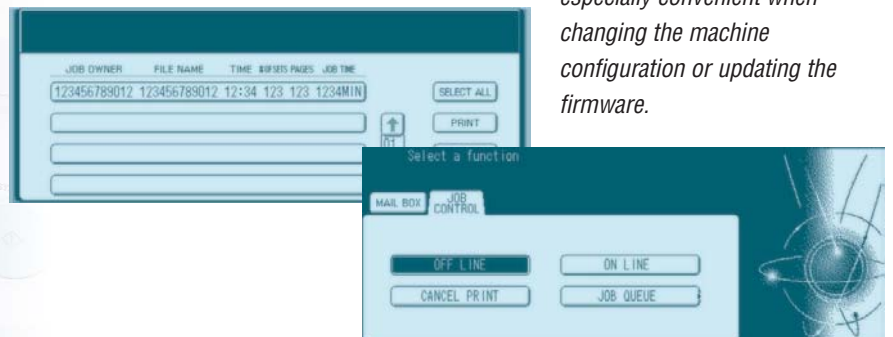

WORKiO Solutions for

Network Scanner & Document Management

High-Speed Scanning with 600 x 600 dpi Resolution

The WORKiO DP-6010 also functions as a **high-speed image scanner***1 that allows you to easily convert documents (up to A3 size) into PC data. High-quality **600 x 600 dpi resolution** and **256-level gray scale** capability assure accurate reproduction of original images and text. With the i-ADF unit, you can load up to 70 pages (A4) and scan an entire **double-sided** multi-page document at one time.



- Network Scanning capability offers easy digitisation of paper documents
- You can convert any paper document into PC data, in a variety of styles.
- Document Manager software makes easy document management possible
- Simple operation and easy handling via comprehensive GUI operation
- Paperless document distribution & seamless fax transmission

WORKiO
Advantages
Got a problem?
WORKiO has a
solution.

“Paper, paper everywhere...”

- Introduction of digital equipment has increased paper flow in your office
- Paper documents are stacked on every desk in your office.
- A deluge of faxes, e-mail, and digital documents is constantly spewing from printers, faxes and copiers

Network Connectivity

With its built-in **10Base-T/100Base-TX Ethernet** interface, the WORKiO DP-6010 can be used as a network scanner*1, transferring scanned documents to any client PC on the LAN. It's a great way to share documents and much more efficient than printing out copies for everyone. The **multi-protocol, multi-network** design ensures that the WORKiO DP-6010 connects, without fail, across Windows® XP/2000/98/Me and Windows NT® 4.0 operating systems.

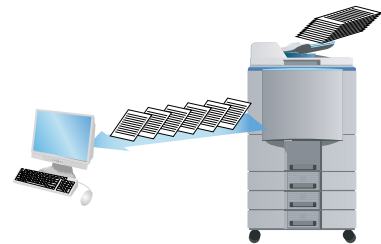

Versatile Network Scanning Capability

With its “push”-type scanning capability, the WORKiO DP-6010 delivers versatile scanning performance on the network. Simply scan the paper documents and send the scanned data to specified PC with **“Scan to PC”***1. With **“Scan to Server”***1, the scanned data can be transferred to an FTP server on the network, so that the required images can be downloaded to the client PC or transferred to another network via Internet.

*1 Optional Network Scanner Module required.



[SCAN / FILE]

easy document management

any paper document into PC data

GUI Screen with Animated Display

When the document is being scanned, an **animated display** on the LCD lets you view the progress of the scanning operation. When scanning has completed, the scanned image appears on the PC display.

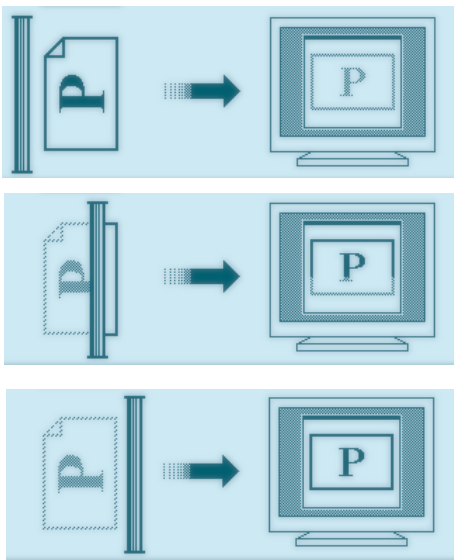

Desktop Document Management

The standard **Document Manager** software enables efficient management of scanned documents and other PC data in an integrated console. When the scanned image arrives on your PC, Document Manager automatically opens and lets you know that the scanned data has been received. You can view, add comments or attach memos to the image with the **Document Viewer**. Using Document Manager, scanned documents can be efficiently managed and edited with the simple **"drag & drop"** operation, even **shared by other network PC's**. The **Panafax Desktop** software, enables you to send a fax directly*2 from your PC without having to print it.

*2 Optional Fax Communication Board required.

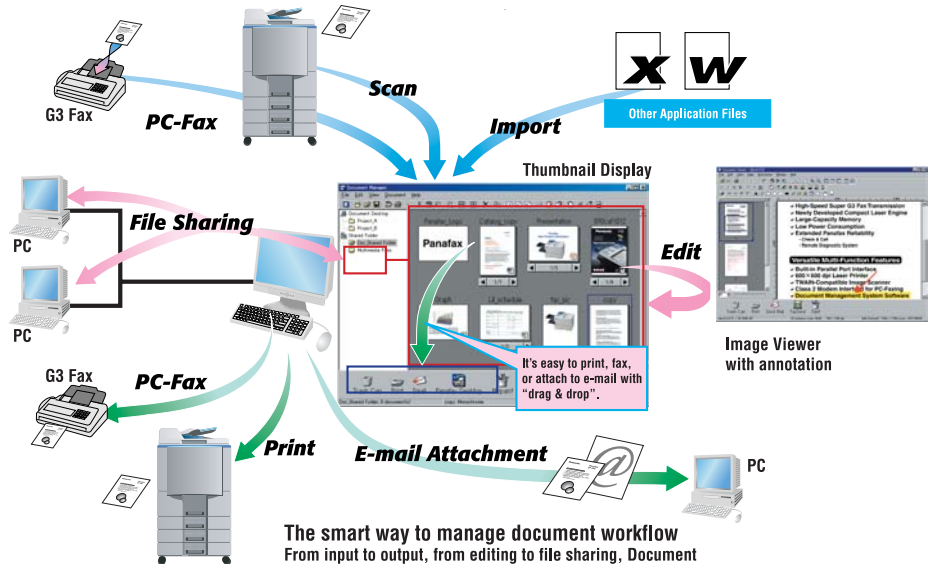

The smart way to manage document workflow
From input to output, from editing to file sharing, Document Manager software streamlines all your document management tasks with simple "drag & drop" operation.

Network Document Management Solution

For larger-scale document management, Panasonic's exclusive **DD Server System***3 is also available as an option for use with a client-server network system. When the optional **DD Server software** is installed in the server, the scanned documents are automatically stored in the DD Server with the DD Code stamped on the cover page of the document. By specifying the cover page of the required file, an entire document can be retrieved quickly from the server and printed on the WORKiO DP-6010. Stored documents can also be retrieved by a network PC from the Document Manager screen. With the DD Server System, you can minimise paper documents in your office and still keep all the original data.

*3 Optional Network Scanner Module required.

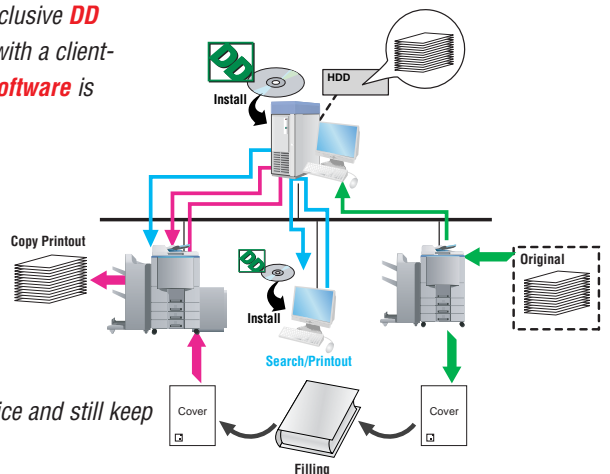

WORKiO Solutions for

Perfect Faxing & Document Distribution

Super Fast Fax Transmission



With the fax communication kit option, you can transform your WORKiO DP-6010 into a high-speed **33.6 kbps Super G3 fax** that transmits a page in about 3 seconds (A4). Besides faster transmission, prep time is also much shorter, thanks to **0.7-sec. Quick-Scan**. And when you send multiple pages, the **Quick Memory Transmission** saves time by connecting to the receiver and beginning transmission while still collecting data.

Enhanced Communication Resolution

Thanks to high-resolution scanning capability, extra-high 600 x 600 dpi resolution is available for G3 fax*1 or Internet fax (Send to E-mail*2) communication. With the **600 x 600 dpi communication resolution**, sharp edges and crisp characters are maintained and reproduced at the destination even when hard-to-reproduce pages with mixed text and images are transmitted via PSTN line or Internet.

*1 Optional Fax Communication Board required.
*2 Optional Internet Fax/E-mail Module required.

“Send to E-mail” for Faxing via Internet

With the Internet Fax option, the WORKiO DP-6010 converts paper documents into TIFF-F image files and transmits them as e-mail attachments via your local area network. With this **“Send to E-mail”***2 feature, you can send the document directly from the WORKiO DP-6010 to other Internet faxes or even multiple e-mail clients worldwide at the touch of a button. When both LAN and PSTN lines are used at the same time,

E-mail/G3 mixed broadcast*3 is convenient way to send the same document to both e-mail addresses and G3 fax machines.

*3 Optional Internet Fax/E-mail Module and Fax Communication Board required.

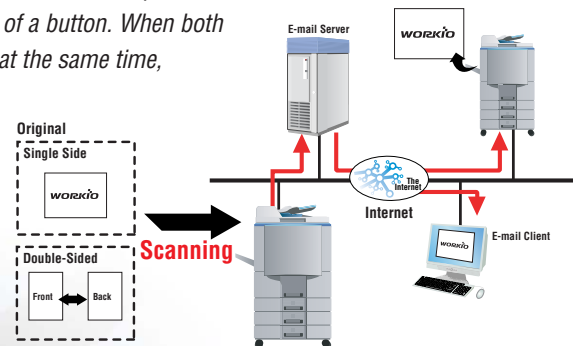

- High-speed Super G3 fax transmission with JBIG compression
- “Send-to-Email” sends handwritten document via e-mail
- Versatile “Send” features enable easy document distribution to multiple recipients

WORKiO Advantages

Got a problem? WORKiO has a solution.

“Sending files is a hassle...”

- Fax transmissions are too slow.
- E-mailing a handwritten document or check sheet involves too many complicated steps.
- Sending a file to multiple PC’s means repeating the same operation over and over again.

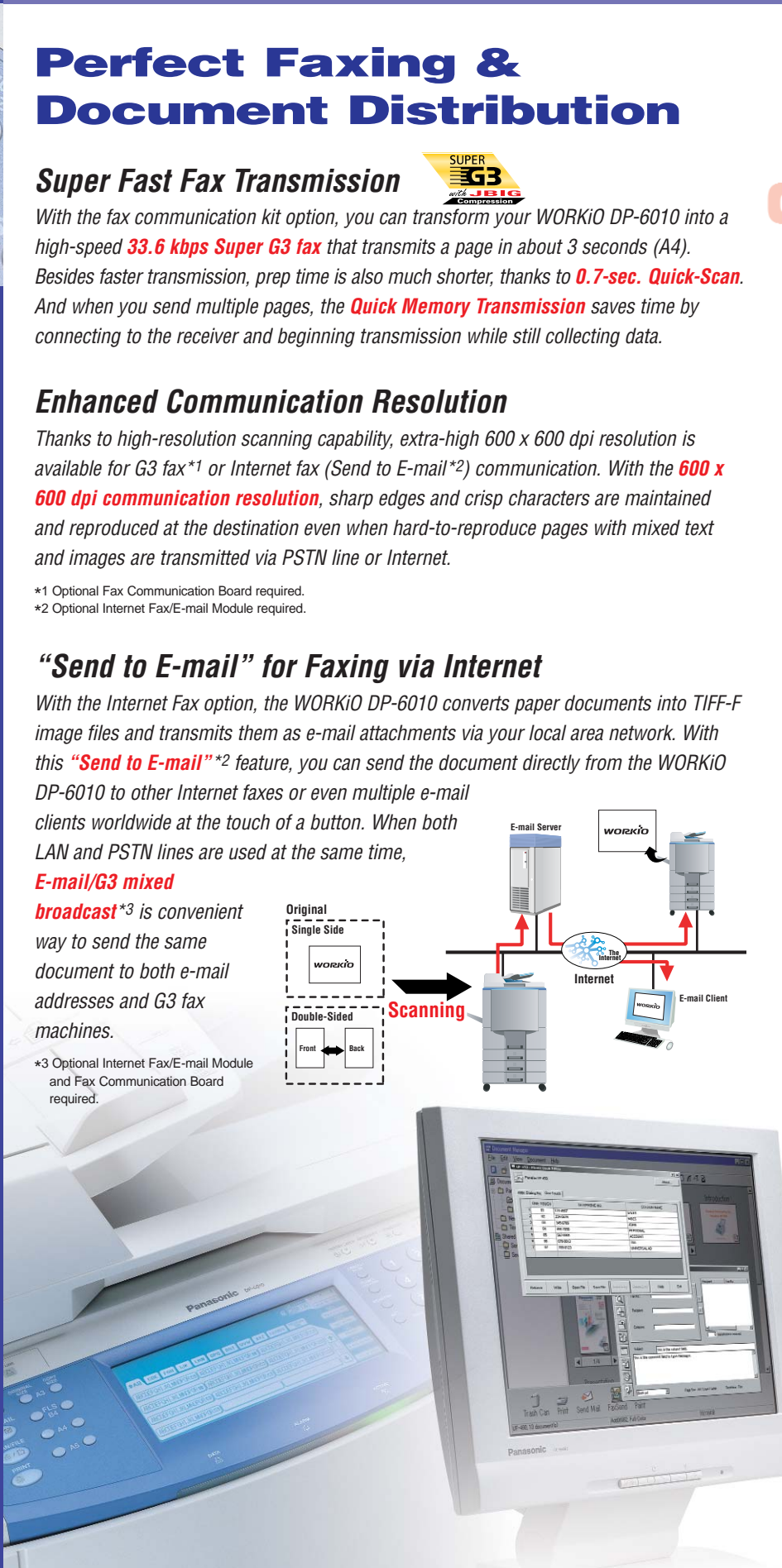

[FAX / EMAIL]

"Send-to-Email"

Paperless Faxing Capability

Since image files sent from the WORKiO DP-6010 as e-mail attachments*2 can be easily opened and displayed using your existing image viewer (i.e., Imaging for Windows®), **paperless fax delivery** is possible.

WORKiO's **fax/e-mail gateway** function automatically routes received faxes to the designated recipient's e-mail inbox. Similarly, documents sent from a PC via the LAN can be transmitted to a G3 fax machine. True paperless faxing is now possible.

"Send" for Versatile File Distribution

Scanned documents are converted into image data that can be easily handled on the PC or via the network. This feature enables you to "send" the scanned file to multiple PC's on the network at the same time ("**Send to PC**"), or "send" it to the server where it can be accessed by any client PC on the LAN ("**Send to Server**"). "**Send to Printer**" allows you to print the file on a WORKiO DP-6010 located in a remote area and even via the Internet.

Sending & E-mail Utility

For quicker access and smoother document transmission, the WORKiO DP-6010's **Address Book** can hold up to 1,000 stations*4. Registered phone numbers and e-mail addresses can be recalled at the touch of a button. Or when the network address is registered with the PC name,



you can quickly specify the PC where the scanned image or job completion notice is to be sent. The E-mail Header utility allows you to easily set up a standardised **e-mail header** with simple PC-like operation.

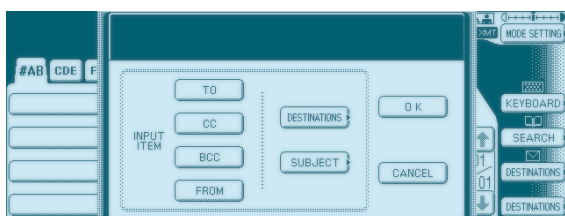

*4 Optional Hard Disk Drive Unit required

Reliability & Durability

Trouble-Free Easy Maintenance Design

The WORKiO DP-6010's **full front-access design** makes it easy for users to maintain. The entire printer engine can be pulled out from the front enabling easy removal of misfeeds. Although the toner and OPC drum are designed for a long service life, replacing them is inevitable. Fortunately, you can easily access the core of the WORKiO DP-6010 and remove and replace the OPC drum or toner bottle. You'll also benefit from Panasonic's exclusive **Remote Maintenance** system. This includes **Check & Call***5, which automatically reports low toner status and various mechanical problems to a service centre, as well as our **Remote Diagnostic System***5, which enables our expert technicians to quickly locate any problems via a telephone line or via the Internet and provide you with a solution.

*5 These functions are not available in certain countries.

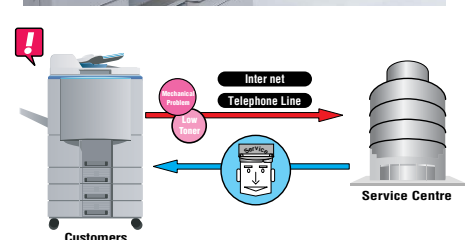

Environmentally Friendly Design

Even with its many functions and powerful performance, the **EnergyStar-compliant** WORKiO DP-6010 requires very little energy to get the job done. The Energy Saver system significantly reduces power consumption when the machine is in idle mode. When the WORKiO DP-6010 enters the sleep mode, power consumption drops to basically nothing. At the same time, its **low-noise, low-ozone emission** design keeps your office environment quiet and clean.



As an ENERGY STAR® Partner, Panasonic has determined that this product meets the ENERGY STAR® guidelines for energy efficiency.

Versatile Options & Expandability

16MB / 64MB / 128MB

DA-SM16B / DA-SM64B / DA-SM28B (Not available in certain countries)

Image Memory Options

Fax / Send to E-mail (Internet Fax) Options

● Select one.

2-Bin Finisher
DA-FS600

Punch Unit
DA-SP31

2-Bin Saddle-Stitch Finisher
DA-FS605

Power Supply for Finisher
DA-PW600
(Optional Power Supply for Finisher is not required in certain countries)

Software / Hard Disk

Accounting System

Hard Disk Drive Unit
DA-HD60

Accounting Software
DA-WA10

DD Server System

DD Server Software
DA-WS20
(Network Scanner Module option is required)

2-Paper Tray Configuration

3-Paper Tray Configuration

4-Paper Tray Configuration

Plain Stand
DA-DA300
(For certain countries only)

System Console 1
DA-DS601

System Console 2
DA-DS602

3000-Sheet Tray
DA-MA301

Flash Memory

4MB Flash Memory / 8MB Flash Memory
UE-410047/UE-410048 (Not available in certain countries)

G3 Fax

Fax Communication Board
DA-FG600

Send to E-mail (Internet Fax)

Internet Fax/E-mail Module
DA-NF600

Expansion F-ROM Board

DA-EM600
(Optional Expansion F-ROM Board is not required in certain countries)

Printer / Network Printer Options

PCL Printer

PCL Printer Controller Module
DA-PC600

PS Printer

Multi Page Description Language Controller Module
DA-MC600

Network Scanner Options

Network Scanner

Network Scanner Module
DA-NS600

Other Option

Key Counter Cable Kit
DZTY000128

Paper Feed Options

DP-6010 Specifications

General / Digital Copier

Type	Semi Console
Copy/Print Process	Laser/Electrostatic photographic method
Warm-up Time	Less than 180 sec.
First Copy Speed	Less than 3.5 sec.
Copy Resolution	600 x 600 dpi
Gray Scale	256 steps
Multi-Copy Speed	60 ppm
Max. Original Size	A3
Copy Size	A3, B4, Foolscap, A4, B5, A5
Copy Ratio	
Enlargement (fixed):	200%, 173%, 141%, 122%, 115%
Reduction (fixed):	87%, 82%, 71%, 58%, 50%
Zoom (variable):	25 - 400% (in 1% increments)
Paper Capacity	1,550 (Large-Capacity Tray) + 550 sheets
Bypass Capacity	50 sheets
Max. Paper Capacity	6,250 sheets with option
Paper Weight	
Paper tray:	60 to 90 g/m ²
Bypass:	55 to 133 g/m ²
Quantity Selector	1 to 999, Automatic reset to 1
Duplex	Standard with "stackless" duplex unit
Exposure Control	Text, Text/Photo, Photo
Sort Memory	Uses JBIG Compression
Standard	32MB
Optional	Base memory (32MB) plus 16MB*1/64MB*1/128MB*1 (max. 160MB) and optional HDD.
Dimensions (W x D x H) (excluding optional equipment)	600 x 758 x 900 mm Main unit with Inverting Automatic Document Feeder
Weight (excluding optional equipment)	Approx. 131 kg
Power Requirements	AC 220 - 240V, 50/60 Hz, 6.5A
Power Consumption	MAX. Less than 1.5kW, 20Wh in Sleep Mode

Auto Document Feeder

Document Capacity	Max. 70 sheets (85 g/m ²)
Document Size	A3 - A5
Original Set	Face Up
Scanning Method	Sheet Through

Printer/Scanner

Printing Speed	60 ppm
Page Description Language	PCL5e, PCL6, PostScript® 3™ (Option)
Standard Printer Memory	20MB
Printing Resolution	1200 dpi equivalent x 600 dpi (PCL)
Paper Size	A3 - A5
Interface	Ethernet 10Base-T/100Base-TX, Bi-directional Parallel (IEEE1284)
Scanning Resolution (Max.)	600 dpi x 600 dpi
Computer Compatibility	Windows® XP/2000/98/Me, Windows NT® 4.0, Mac OS 8.6 or later (PS only)

G3 Fax

Compression Method	MH, MR, MMR, JBIG
Modem Speed (Max.)	33.6 kbps
Resolution	600 x 600 dpi
Fax Memory Capacity	2MB (Max. 10MB*1)
	Uses non-volatile Flash ROM
Transmission Speed	Less than 3 sec.
No. of Auto Dialers	200 (Max. 1000 with optional HDD)

Send to E-mail / Internet Fax

Compatibility	IETF RFC 2305, ITU-T T.37
Communication Protocol	TCP/IP, SMTP, POP3, MIME
Network Connectivity	Ethernet 10Base-T/100Base-TX [IEEE802.3]
Data Format	TIFF-FX, Profile S, MMR

Dimension

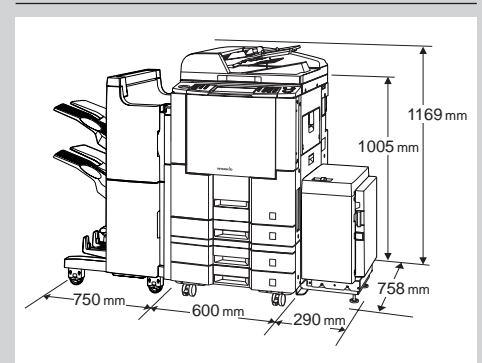

Notes

*1 Not available in certain countries.
Microsoft, Windows and Windows NT are registered trademarks of Microsoft Corporation.
Adobe, PostScript and PostScript logo are trademarks of Adobe Systems, Inc.
PCL is a registered trademark of Hewlett-Packard.
WORKIO is a registered trademark of Matsushita Graphic Communication Systems, Inc.
All other brand or product names are the property of their respective holders.

Design and specifications are subject to change without notice.
Not all options may be available at the time of introduction.

ISO 9001 Quality Management System

Every aspect of Matsushita Graphic Communication Systems, Inc. (MGCS)'s office information equipment business processes, from manufacturing to marketing, conforms to ISO (International Organisation for Standardisation) 9001 quality management system standard.

Design, development, manufacture, installation, repair and maintenance of office information equipment, their associated devices and consumables.



In addition, MGCS's plants outside Japan have acquired ISO 9002 certification.

Panasonic

Panasonic and National are the brandnames of Matsushita Electric.

Matsushita Electric Industrial Co., Ltd.
Matsushita Graphic Communication Systems, Inc.



As an Energy Star® Partner, Panasonic has determined that this product meets the Energy Star® Guidelines for energy efficiency.