



Paper to digital, input to output...
document handling has never been
this easy and efficient.

The WORKiO line of digital imaging systems is dedicated to making information handling as easy as possible. Whether you are copying, printing from your PC, faxing, e-mailing as an attached file or simply storing documents as digital files for easy retrieval later, WORKiO does it all. Now Panasonic has used its expertise in designing and engineering reliable and user-friendly equipment to create the new WORKiO DP-1810F. It's the multi-function copier/printer/fax/scanner that's ideal for small workgroups and growing businesses.



DP-1810F Features

Digital PPC		
• Auto Magnification Selection (with ADF)	• Image Rotation (90 degrees)	• Book Mode
• Auto Paper Selection (with ADF)	• Electronic Sort	• 2 Page Copy Mode
• Job Memory (2)	• Rotation Sort	• 2 in 1 (with ADF)
• Interrupt Mode	• Skyspot Mode	• Edge Erase Mode
• Margin Mode		
Panasonic Document Management System*1		
• Document Manager	• Document Viewer with Annotation function	• Panafax Desktop (PC-Fax)
• Document Scanner	• Status Monitor	• Phone Book Editor
• Configuration Editor		
Printer		
• Collation Stack	• Rotate Sort *3	• Security Print
• N in 1 (2 in 1, 4 in 1)	• Image Overlay (Only for Windows® 98/Me)*3	
• Network Printing *2		
G3 Fax		
• 3-second Super G3 Transmission	• Batch Transmission	• Deferred Transmission
• Verification Stamp	• Quick Memory Transmission	• Password XMT / RX
• 90° Rotation Transmission / Reception	• Polling Transmission / Reception	
	• Multi-station Transmission	
Send to E-mail / Internet Fax		
• G3 / E-mail Mixed Broadcasting	• Subject Line Entry	• E-mail Header Print Selection
• E-mail Relay Transmission to G3 Fax	• 400dpi Network Scanner	• Received Fax / E-mail Forward
Others		
• Multi-Task Operation	• Energy Saver Mode	• Check & Call Function
• Self Diagnostic Function	• Department Counter (50 departments)	
• Remote Diagnostic System		

Options

You can select a number of options that make the WORKiO DP-1810F more efficient and versatile.

Handset Kit*4 UE-403117	Optional Image Memory 2MB (UE-410046) 4MB (UE-410047) 8MB (UE-410048)
10/100 Ethernet Interface / Internet Fax kit DA-NE200	Function Enhancing Options
PCL6 Emulation Kit DA-PC210	Image Memory for Electronic Sort
Image Memory for Electronic Sort	DA-SM08B (8MB)
	DA-SM16B (16MB)
	DA-SM48B (48MB)*4
	DA-SM28B (128MB)*4
Key Counter Cable Kit DA-KH200	
Toner Bottle DQ-TU10C	

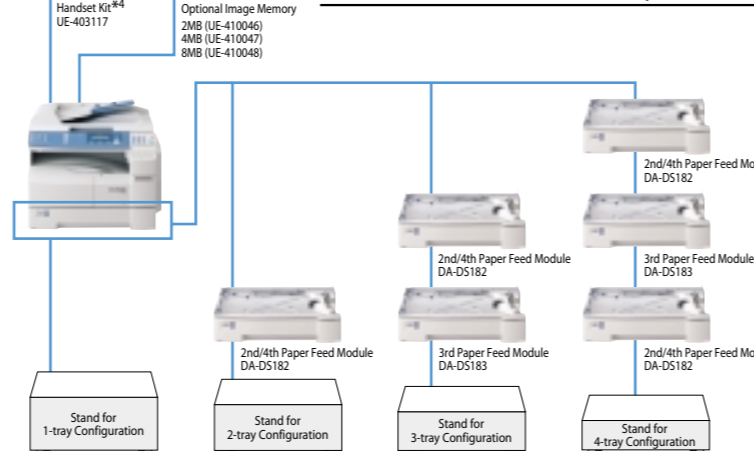

ISO 9001 Quality Management System

Every aspect of Matsushita Graphic Communication Systems, Inc. (MGCS) office information equipment business processes, from manufacturing to marketing, conforms to ISO (International Organisation for Standardisation) 9001 quality management system standard. Design, development, manufacture, installation, repair and maintenance of office information equipment, their associated devices and consumables.



In addition, MGCS's plants outside Japan have acquired ISO 9002 certification.

Dimensions

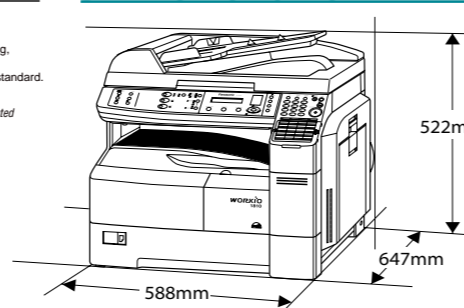

Panasonic
Panasonic and National are the brand names of Matsushita Electric.

Matsushita Electric Industrial Co., Ltd.
Matsushita Graphic Communication Systems, Inc.

Control Panel



DP-1810F Specification

Basic / Digital PPC	
Type	Desktop
Copy / Print Process	Laser Electrostatic photographic method
Developing Process	Dry type single component imaging
Warm-up Time	Approx. 30 sec.
First Copy Time	6.5 sec. (A4)
Resolution	600 dpi
Gray Scale	256 steps
Multi Copy Speed	18 cpm (A4)
Maximum Original Size	A3
Copy Size	A3, B4 Foolscap (8.5" x 13", 8" x 13"), A4, A5
Copy Ratio	Enlargement (fixed) 200%, 173%, 146%, 141%, 137%, 127%, 122%, 115%, 103% Reduction (fixed) 97%, 90%, 87%, 82%, 73%, 71%, 68%, 64%, 58%, 50%
Zoom (variable)	50-200%
Automatic Document Feeder	50 sheets (A4) / 30 sheets (A3, B4)
Paper Feed	550-sheet paper tray x 1 + 50-sheet bypass Max.: 2,250 sheets with optional paper tray x 3
Multiple Copy	999
Exposure Controller	Text, Text/Photo, Photo
Page Memory Capacity	16MB
Sort Memory Capacity	8MB
Optional Memory	Base Memory plus 8MB / 16MB / 64MB*4 / 128MB*4
Power Requirement	AC220-240V 50/60 Hz Single phase
Power Consumption	Max.: Less than 1.2 kW Energy Saver mode: Approx. 38 Wh Sleep mode: Approx. 2.2 Wh
Dimensions (W x D x H)*5	588 x 647 x 522 mm Including ADF and ADF mounting bracket
Weight*5	45 kg
Printer / Scanner	
Printer Interface	Bi-directional Parallel (IEEE1284) Network (Ethernet 100Base-TX/10Base-T) with optional 10/100 Ethernet Interface / Internet Fax kit
Printing Speed	18 ppm (A4)
Printing Resolution	600 dpi
Scanning Resolution	600 dpi
Scanner Driver	TWAIN
OS	Windows® 98 / Me / XP / 2000, Windows NT® 4.0
Page Description Language	PCL6 Emulation (with optional PCL6 Emulation Kit)
G3 Fax	
Compatibility	ITU-T Group 3, ECM
Modem Speed	33,600 - 2,400 bps with automatic fallback
Coding Scheme	JBIG / MMR / MR / MH
Transmission Speed	Approx. 3 second / page*6
Scanning Speed	0.7 sec. (A4 portrait in Standard or Fine mode)
Scanning Resolution	Standard: 8 dots / mm x 3.85 lines / mm Fine: 8 dots / mm x 7.7 lines / mm Super Fine: 16 dots / mm x 15.4 lines / mm
Effective Scanning Width	292 mm
Recoding Resolution	Max. 406 dots / inch x 391 line / inch
Standard Memory	Approx. 120 pages*7
Optional Memory	Base memory plus 160 pages (2MB)*6 / 320 pages (4MB)*6 / 640 pages (8MB)*6
Send to E-mail / Internet Fax (Option)	
Compatibility	IETF RFC 2305, ITU-TT.37
Communication Protocol	TCP / IP, SMTP, POP3, MIME
Network Connectivity	100BASE-TX / 10BASE-T Ethernet (IEEE802.3)
Data Format	TIFF-FX Profile S, MMR (400 dpi only)

Notes

*1 Local connection only.
*2 Optional 10/100 Ethernet Interface / Internet Fax kit is required.
*3 Optional PCL6 Emulation Kit is required.
*4 May not be available in certain countries.
*5 Dimensions and weight are approximate.
*6 Transmission time applies to memory transmission of text data with JBIG compression using only ITU-T Image No.1 between the same models at modem speeds over 26.4 Kbps. Transmission time may vary in actual usage. Usually public telephone lines can support only 28.8 Kbps or lower communication speed. Via PBX, transmission speed may back to a lower speed.
*7 Based on ITU-T Image No.1 scanned in Standard mode.

Microsoft®, Windows® and Windows NT® are registered trademarks of Microsoft Corporation. PCL6 is a registered trademark of Hewlett-Packard. WORKiO is a registered trademark of Matsushita Graphic Communication Systems, Inc. All product names are trademarks of their respective holders. Design and specifications are subject to change without notice.

MG-C398EE 0203 Printed in Japan

WORKiO™
DIGITAL IMAGING SYSTEMS

Panasonic
DP-1810F

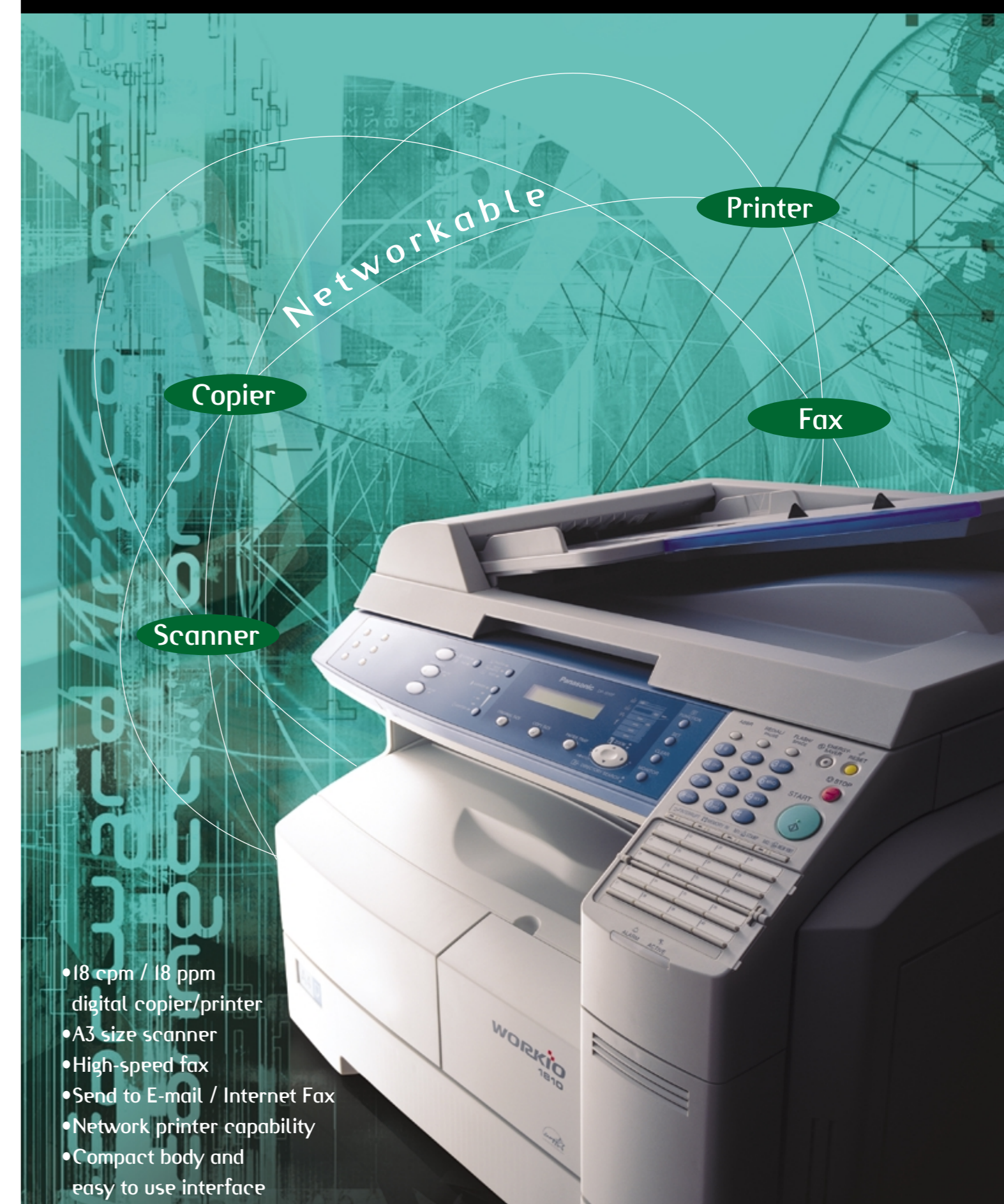

- 18 cpm / 18 ppm digital copier/printer
- A3 size scanner
- High-speed fax
- Send to E-mail / Internet Fax
- Network printer capability
- Compact body and easy to use interface

The compact, versatile solution to all the needs of a small to medium office or workgroup.

You need a copier, printer and scanner, and want them networked with your PCs. However, your office space is limited.

THE WORKiO SOLUTION – 1

Space-saving design with multi-function convenience.

The WORKiO DP-1810F combines copier, scanner and network printer functions in a compact unit. It handles paper as large as A3 size, yet fits neatly on a desktop corner because there are no protruding paper trays. The scanner and Document Management software make it easy to use a PC to save documents as digital files, edit them in various ways, and share them with everyone on the network.

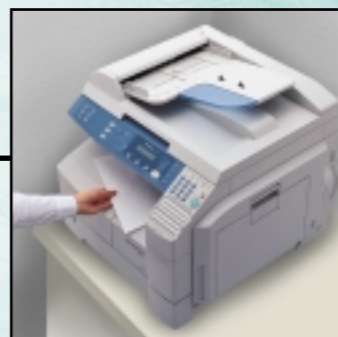

You want fax capability, but don't have the space or budget for a separate machine. You are also worried about fax costs.

THE WORKiO SOLUTION – 2

High-speed Super G3 fax is built in.

Now you can have full fax capabilities in the same machine with your copier and printer. The Super G3 fax transmits a page in only three seconds, and sends and receives documents up to A3 size. Transmission time and cost is further reduced by Quick-Scan* that cuts prep time to 0.7 seconds and Quick Memory Transmission that makes the connection while still storing the first page.

* A4 portrait scanned in fine or standard mode

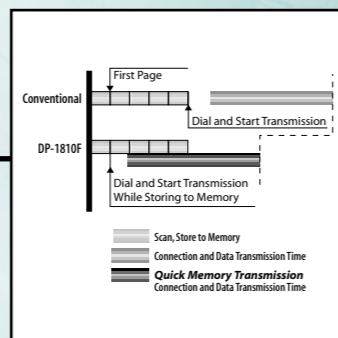

Faxing is great, but sometimes you want to e-mail documents – especially those long documents to overseas addresses.

THE WORKiO SOLUTION – 3

Send to E-mail function speeds document distribution.

The WORKiO DP-1810F offers a Send to E-mail function that instantly converts paper documents into digital information for e-mail transmission. Because internet transmission is much faster than ordinary phone lines, costs are lower, especially for high volume and long-distance faxing.

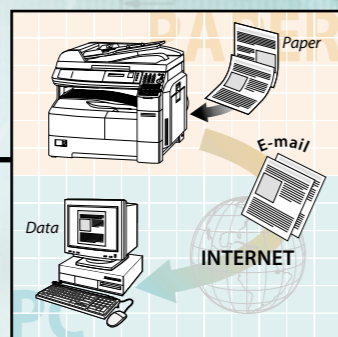

You want a machine that meets your needs without being complicated – a machine that everyone finds easy to use.

THE WORKiO SOLUTION – 4

A well designed front panel with only the features you need.

The WORKiO DP-1810F offers the features a growing business needs, without excess complexity. Following Universal Design principles for ease of use and accessibility, the control panel is set low and angled for convenient operation. The clean layout has buttons that are easy to see and operate.



High-Speed Digital Copier/Printer

As a digital copier, this versatile machine delivers a brisk 18 pages per minute and offers a variety of efficient features. It also doubles as a laser printer, handling pages up to A3 size in both modes.

Networkable A3-Size Laser Printer

Connected to your PC, the WORKiO DP-1810F becomes a high-speed 18 ppm laser printer with 600 x 600 dpi resolution. An optional 10/100 Ethernet Interface makes it ready for use as an office network printer, and an optional PCL6 Emulation Kit makes it a fast network printer.

Digital Skyshot

Enables you to copy small-size originals without annoying black borders.

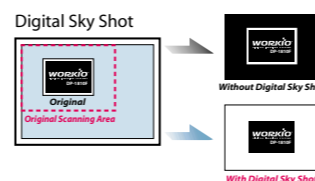

Image Rotation

You get accurate copies regardless of the original's orientation.



2-in-1 copying

This handy function reduces paper usage by fitting two reduced images on one sheet.

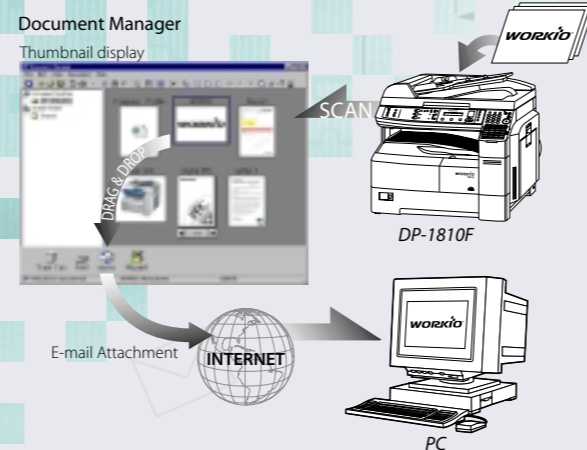
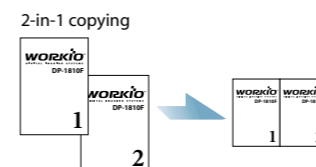

The WORKiO DP-1810F comes supplied with Document Management software that gives you efficient, versatile control over your documents. Installed in your PC, it makes your scanned-in data easy to manage, edit and even share on network PCs. Images can be manipulated in many ways, including superimposing text and graphics.

When you install the supplied Panafax Desktop software, you can send and receive faxes with your PC – no paper is necessary. Faxes can even be handled with quick drag-and-drop control.

The DP-1810F incorporates a class 2 standard compliant fax modem. Even if the PC is not equipped with a modem, the DP-1810F can function as an external PC modem so you can use PC Fax Function Software* to send faxes via the PC.

* Recommended: WinFax Pro 10.0.

Panafax Desktop (PC-Fax)



High-Speed Fax with Networking Capabilities

The WORKiO DP-1810F gives you high-speed fax capability with simple, convenient operation and a number of attractive options. The Super G3 fax modem speeds out pages in only three seconds, while Quick Scan and Quick Memory Transmission cut connection time even further. JBIG Compression means photos are sent quickly, too. For even faster transmission of documents, choose the Send to E-mail option. You can

fax large sheets up to A3 size, and the flatbed scanner lets you easily fax book pages. Operation is simple, and includes one-touch dialing to 60 addresses. What's more, the machine can use the fax to automatically transmit status reports to a service centre, ensuring timely maintenance for lower costs and downtime.

Send to E-mail / Internet Fax*

This option allows you to send and receive faxes to and from PCs as e-mail. You can transmit photos or handwritten information as e-mails, and faxes are received as digital files, ready for display by the PC's image viewer or by installing the free Panasonic TIFF-Viewer*.

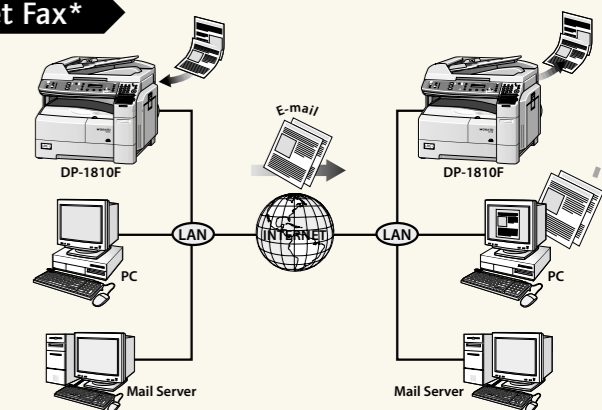

Network Scanner*

The WORKiO DP-1810F can also function as the scanner for the PCs on your LAN network. Simply scan a document, then e-mail it to any or all of the computers on the network. It arrives as a digital document, ready for editing or printing.

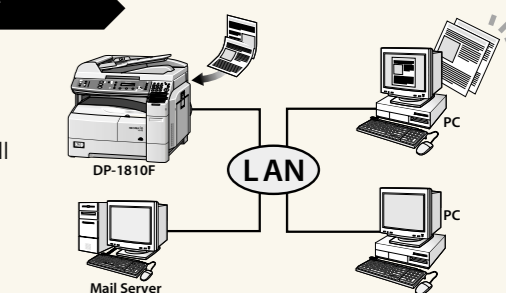

E-mail/G3 Fax Mixed Broadcast*

By using both LAN and PSTN lines at the same time, you can simultaneously send documents as both e-mail and faxes. Since you do not need to worry about which destinations use e-mail or facsimile, broadcast transmissions to multiple recipients are much easier and more efficient.

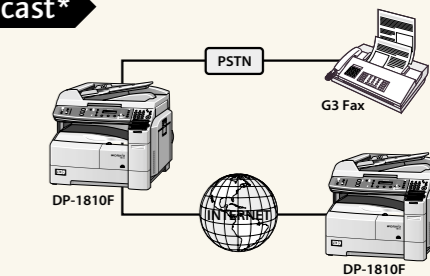

* Panasonic's free Windows NT® 4.0 and Windows® XP/2000/98/95/ME compatible TIFF Viewer, TIFF Converter and mail linking program for MAPI (Mail Application Program Interface) can be downloaded from the following website: <http://www.panasonic.co.jp/mgcs/internetFAX/>. Please read the license agreement before installing the software.

* Optional 10/100 Ethernet Interface / Internet Fax is required.

Energy-Saving Design

The WORKiO DP-1810F has a number of features designed to conserve energy and keep operating costs to a minimum. The Energy Saver Mode significantly reduces power consumption when the machine is idle. And in Sleep Mode, power consumption drops to approximately 2.2Wh.



As an ENERGY STAR® Partner, Panasonic has determined that this product meets the ENERGY STAR® guidelines for energy efficiency.

Versatile Document Management System